

SC6.2 Character residential planning scheme policy

SC6.2.1 Introduction

Short Title -The planning scheme policy (PSP) may be cited as the Character residential PSP.

SC6.2.1.1 Purpose

The purpose of the planning scheme policy is to:

- (1) provide advice about achieving outcomes in the [Character residential zone code](#); and
- (2) identify and provide guidance about information that may be required to support a development application where assessable against the Character residential zone code.

SC6.2.1.2 Legislative authority

This planning scheme policy is made under Chapter 2, Part 3 of the [Planning Act 2016](#).

SC6.2.1.3 Relationship to the Townsville City Plan

This planning scheme policy is to be read in conjunction with the assessment provisions specified in the Townsville City Plan, specifically the Character residential zone code.

SC6.2.1.4 Terminology

Terms used in this planning scheme policy are defined in Schedule 1 – Definitions. A term used in the planning scheme policy which is not defined in [Schedule 1 – Definitions](#), is to be interpreted in accordance with [Part 1.3.1](#).

SC6.2.2 Planning scheme policy details

The Character residential zone identifies and defines parts of the city with a unique mixture of architecture and overall streetscape. The [Character residential zone code](#) regulates development within identified character precincts. This code ensures that the features of these neighbourhoods that make a positive contribution to each precinct's overall character are retained and appropriately managed.

There are twelve precincts in the Character residential zone code, each with its unique features (such as Workers Cottages, Grand Queenslanders and 1960s Defence Housing). The precincts provide for specific development outcomes over and above the general zone code outcomes. Individual properties are included within a precinct. The character features are described fully in the code.

The purpose of the Character residential PSP is to provide applicants with guidance in meeting the requirements of the Character residential zone code. Appendix 1 of this policy identifies non-contributing properties in the Character residential zone. Properties and buildings identified in the Character residential zone and not listed in Appendix 1 of this policy are considered to be contributing properties and buildings. Appendix 2 of this policy identifies contributing non-residential properties.

SC6.2.2.1 Understanding your precinct and your character building

Each character residential precinct is defined in the Character residential zone code. Townsville has defined character residential precincts; these precincts are rich in diversity, unique in character, and capture Townsville's history and North Queensland lifestyle.

- (1) Your precinct
The buildings in your street create the character of your precinct. Properties are defined as either contributing character buildings or non-contributing properties. Non-contributing properties must still comply with certain provisions of the Character residential zone code, however; they are not to be used for comparative assessment.

Your street will provide the majority of the information you need to better understand the types of buildings, design, developments and architectural aspects that will be relevant to any new works on your property.

SC6.2.2.2 Finding your way around the policy

The policy is divided into the following eight sections:

- (1) Key contributing character elements (SC6.2.3)
- (2) Non-residential contributing character buildings (SC6.2.4)
- (3) Reconfiguring a lot (SC6.2.5)

- (4) Information that may support a development proposal (SC6.2.6)
- (5) Preparing an assessment report (SC6.2.6.2)
- (6) Preparing a condition report (SC6.2.6.3)
- (7) SC6.2 Appendix 1: Non-contributing properties in the Character residential zone
- (8) SC6.2 Appendix 2: Contributing non-residential properties

SC6.2.3 Key contributing character elements

SC6.2.3.1 Roofs

This section of the policy provides design principles and examples that may be considered when addressing the requirements of the [Character residential zone code](#). Applicants may refer to this section for guidance on Character residential zone code outcomes regarding roof forms and pitch, material type and colour and depth of roof overhang.

- (1) Figure SC6.2.3.1 below demonstrates acceptable roof pitch in relation to neighbouring properties. This may provide guidance in addressing roof pitch related outcomes of the Character residential zone code requirements in particular, in relationship to PO18, PO21, PO28, PO33, PO40, PO45, PO51, PO56, PO63, PO69, PO74 and PO80.

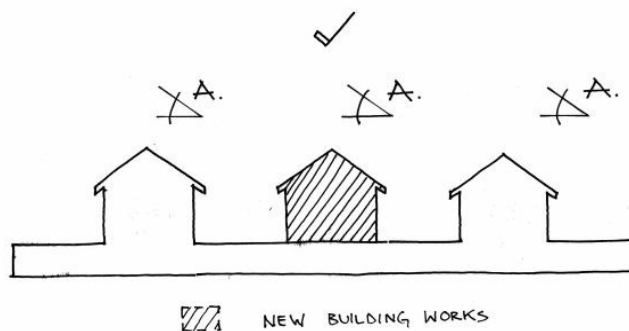

Figure SC6.2.3.1 Illustrates an example of acceptable roof pitch

- (2) Figure SC6.2.3.2 below demonstrates an unacceptable roof pitch in relation to addressing roof pitch related outcomes of the Character residential zone code requirements in particular, in relation to PO18, PO21, PO28, PO33, PO40, PO45, PO51, PO56, PO63, PO69, PO74 and PO80.

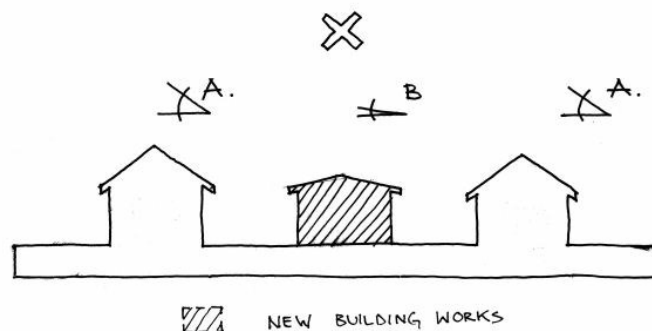

Figure SC6.2.3.2 Illustrates an example of unacceptable roof pitch

- (3) Figure SC6.2.3.3a and Figure SC6.2.3.3b identifies some examples of compatible roof pitches found in various character residential precincts. These may be considered in addressing Character residential zone code requirements relating to roof pitch.

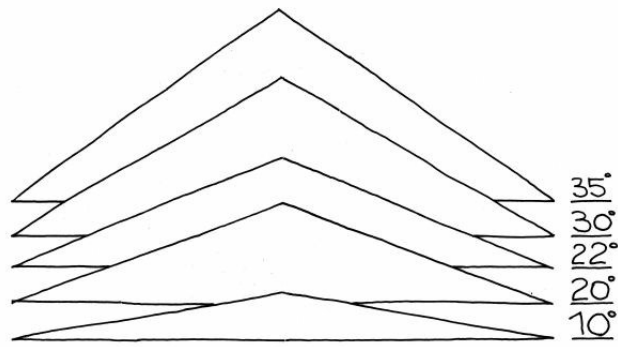
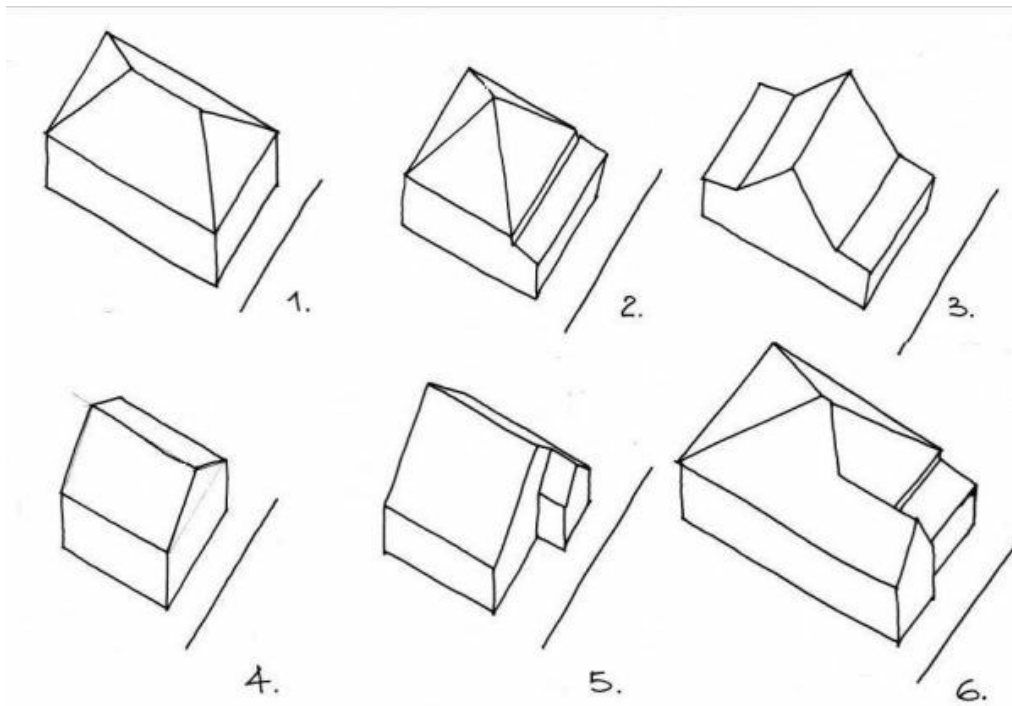

Figure SC6.2.3.3a Illustrates an example of common roof pitches in character residential precincts



Note—the resulting roof may be expressed as a combination of any number of roof forms:

- (1) hip roof;
- (2) pyramid roof with skillion/lean-to verandah;
- (3) side gable roof with skillion/lean-to verandahs;
- (4) front gable roof;
- (5) double gable roof (sometimes expressed as triple gable roof); and
- (6) combination of gable and hip roofs, with skillion/lean-to verandah.

Figure SC6.2.3.3b Illustrates an example of common roof forms in character residential precincts

- (4) Figure SC6.2.3.4 provides guidance on the identification of roof eave depth. This figure may assist in the determination of eave depth in particular, in relation to PO19, PO22, PO57, PO64, PO75 and PO81 of the Character residential zone code.

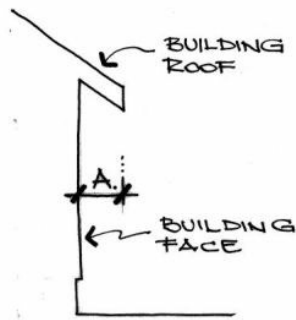

Figure SC6.2.3.4 Illustration of the roof eave depth which is shown by measurement "A"

SC6.2.3.2 Verandahs and front facades

A front verandah or an articulated front façade is commonly observed as a fundamental element of character within some precincts. This section of the policy provides examples of variation in verandah design, including scale (width, depth) enclosure, setback and height above ground level (see Figure SC6.2.3.5 for illustration of terms).

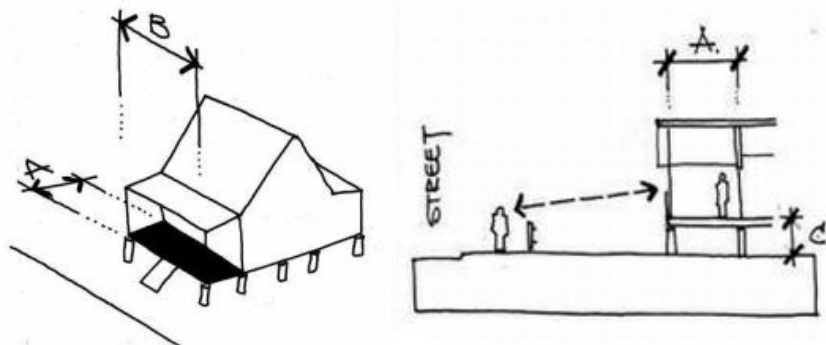

Figure SC6.2.3.5 - Demonstrating the width (B), depth (A), enclosure, setback, and height above ground level (C) of a front verandah

- (1) Figure SC6.2.3.6 below illustrates 100% of the front façade width containing a verandah (left), and also an example of a property with a front façade including a verandah for a minimum 60% width of the front façade, wrapping down one side, and includes an asymmetrical projecting front gable (right). Both are open verandahs and are elevated above the natural ground level.

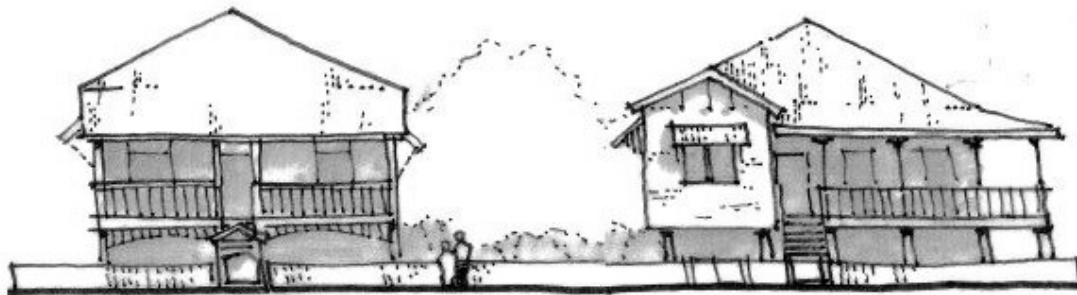

Figure SC6.2.3.6 Illustrates examples of a front verandah

- (2) Figures SC6.2.3.7- SC6.2.3.9 illustrate examples of variation in verandah design including open, enclosed, and semi-enclosed and their supporting character elements.



Figure SC6.2.3.7 Illustrates an example of a front verandah, semi enclosed with screening and a door



Figure SC6.2.3.8 Illustrates an example of an open front verandah Workers Cottage style



Figure SC6.2.3.9 Illustrates an example of an open front verandah, Grand Queenslander style

- (3) Figure SC6.2.3.10 and SC6.2.3.11 shown below, may be considered as a compatible outcome in relation to PO48, and PO71 and PO 78 of the Character residential zone code. The figures illustrate an example of projecting built forms that may be incorporated into building design in character precincts that do not include a verandah.



Figure SC6.2.3.10 Illustrates an example of a front façade with projecting gable features



Figure SC6.2.3.11 Illustrates an example of a front façade with single asymmetrical projecting gable

SC6.2.3.3 Windows

- (1) Figure SC6.2.3.12 shown below, illustrates examples of sympathetic window scale and proportion. These examples provide guidance for addressing outcomes PO20, PO23, PO29 PO34, PO46, PO52, PO58, PO65, PO76 and PO82 of the [Character residential zone code](#).

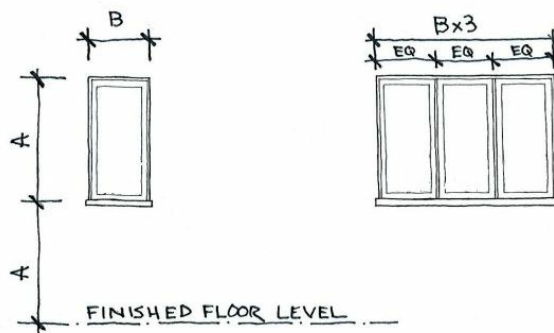

Figure SC6.2.3.12 Illustrates an example of half-height, vertically proportioned windows with one frame (left) and a set of three frames (right)

- (2) Figure SC6.2.3.13 shown below, illustrates examples of window hoods in relation to the predominant character of the precinct. This information may be considered in addressing outcomes PO29 and PO34 Character residential zone code requirements regarding sympathetic window scale and proportion.

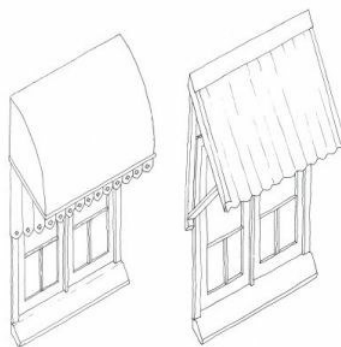

Figure SC6.2.3.13 Illustrates an example of traditional window with hood (left), and an acceptable new window with hood reflecting the same scale and proportions (right)

- (3) Figure SC6.2.3.14 - SC6.2.3.17 shown below, illustrates examples of typical windows in character precincts. This information may be considered in addressing outcomes PO20, PO23, PO29 PO34, PO46, PO52, PO58, PO65, PO76 and PO82 of the Character residential zone code.

- (a) casement windows and louvers;



Figure SC6.2.3.14 Illustrates an example of two vertically proportioned casements and louvers either side, centrally located under the apex of a gable projection



Figure SC6.2.3.15 Illustrates an example of five vertically proportioned casements located under the apex of a gable projection

- (b) bay windows; and



Figure SC6.2.3.16 Illustrates an example of projecting bay window with four casement frames two located centrally and one either side

- (c) full height windows.



Figure SC6.2.3.17 Illustrates an example of a full height window, acceptable in 1960's Defence Housing Precinct only

SC6.2.3.4 Building materials

Lightweight construction materials are typical within Townsville's character residential precincts. Lightweight construction materials are traditionally "timber and tin" products. New works within a character residential precinct can replicate lightweight construction using other materials, provided the appearance of lightweight construction is achieved. This section provides guidance on how to achieve PO15 of the Character residential zone code.

- (1) Buildings and new works can use materials that are lightweight in appearance and sympathetic with the character of the streetscape. Where traditional lightweight materials are not able to be used, non-lightweight materials are acceptable, provided the materials and methods used reflect the appearance of lightweight construction.

An example of an acceptable construction (Figure SC6.2.3.18, left) shows non-lightweight materials that reflect lightweight construction by referencing a raised appearance using textured cladding. An example of an unacceptable construction (right) shows a rendered wall that does not reference a lightweight appearance.

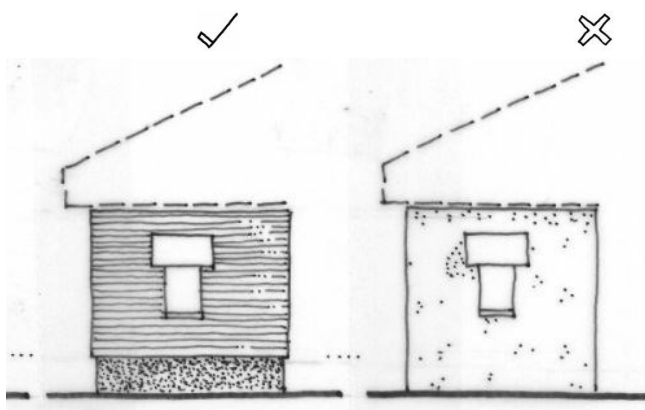

Figure SC6.2.3.18 An example of an acceptable construction (left), and an unacceptable construction (right)

- (2) The design materials and principles below provide acceptable examples which can be considered for achieving PO15 of the Character residential zone code.
 - (a) Typical use of expressive materials in the Character residential zone precincts includes:
 - (i) chamferboard: A common exterior timber cladding. Several profiles of chamferboard exist, produced in several timber types, such as silky oak, cedar and hardwoods (as shown in Figure SC6.2.3.19);



Figure SC6.2.3.19 Illustrates traditional use of timber chamferboard on external walls

- (ii) expressed studwork: Typical of traditional timber framed homes. A practice of fixing the weatherboards to the inner surface of the stud frame and leaving the outer surface uncovered. Evolved to be both functional and decorative (as shown in Figure SC6.2.3.20);



Figure SC6.2.3.20 Illustrates traditional use of expressed studwork walls

- (iii) manufactured cladding: Exterior building veneer material. Can be used as an overlay to an existing exterior; some cladding products are known as siding. Manufactured cladding can be used to mimic traditional materials such as chamferboard (as shown in SC6.2.3.21);



Figure SC6.2.3.21 Illustrates new works using manufactured cladding in imitation of traditional lightweight materials

- (iv) corrugated galvanised iron: A common roofing material in Australia (as shown in Figure SC6.2.3.22); and



Figure SC6.2.3.22 Corrugated galvanized iron is typical for roofing in Townsville Character buildings

- (v) masonry is acceptable for use with external walls where it is finished in the appearance of lightweight construction, and/or used in conjunction with lightweight cladding materials (as shown in Figure SC6.2.3.23).



Figure SC6.2.3.23 Illustrates desirable outcome of a masonry constructed home with a "lightweight appearance"

SC6.2.3.5 Maintaining the street rhythm (scale and proportion)

Maintaining the street rhythm within a character residential precinct is paramount to preserving the character of any particular precinct. Street rhythm can be maintained by repeating the scale and proportions of the character buildings that are predominant in the streetscape. This can be achieved in terms of building heights, setbacks from the street, width of the front facades, and elevation of the floor levels.



Figure SC6.2.3.24 Illustrates an example of an acceptable ground floor enclosure

Figure SC6.2.3.24 illustrates an acceptable example; a raised character building that has been enclosed on the ground level, recessed the full width of the front verandah, using complementary materials and includes a valance in appropriate scale and proportion (this may be considered in addressing numerous Character residential zone code outcomes).

SC6.2.4 Non-residential contributing character buildings

SC6.2.4.1 Non-residential uses

This section of the policy provides guidance in relation to addressing outcome PO35 of the [Character residential zone code](#). In particular, for those properties listed in [Appendix 2 - Contributing non-residential properties](#).

In the South Townsville precinct, non-residential uses and buildings are a contributing element to the precinct's defined character. These non-residential buildings and uses reflect the early settlement and lifestyle of South Townsville.

- (1) Typical elements of non-residential contributing character buildings in the South Townsville precinct include:
 - (a) no setback to street boundaries, and provide an awning and footpath for the full extent of the primary street frontage (as shown in Figure SC6.2.4.1 and Figure SC6.2.4.2); and

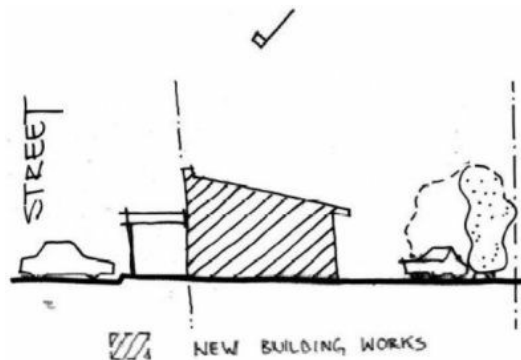

Figure SC6.2.4.1 Non-residential building with no setback to street boundary, awning over the footpath and parking on the street or behind the building

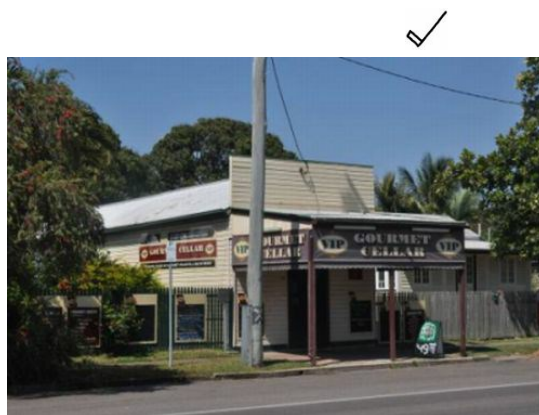

Figure SC6.2.4.2 Existing acceptable example of a non-residential use in an acceptable non-residential building (no setback to street boundary and awning over footpath)

- (b) utilise on-street car parking, and/or on-site parking is behind the building and obscured by landscaping screen.

Note—where an existing non-residential non-contributing character building is not retained, the site may be converted to a residential use to match the scale and rhythm of adjacent contributing character residential buildings.

SC6.2.5 Reconfiguring a lot

The following design principle is provided as material for consideration when addressing PO11 of the [Character residential zone code](#).

- (1) To maintain the rhythm and consistency of the streetscape, the installation of a fence that is tapered in height from the street front to the front façade of the building may be considered (Figure SC6.2.5.1 illustrates an acceptable outcome).



Figure SC6.2.5.1 Illustrates access strip fencing tapered from the front façade of the building to the street boundary (measurements are provided only as an example)

SC6.2.6 Information that may support a development proposal

SC6.2.6.1 Elevations and streetscape

Development proposals should provide clear representations of the relationship between adjacent contributing character buildings and the proposed works to ensure that the design of development is undertaken with a clear understanding of the surrounding context.

Development applications should provide front/street elevations of the proposed works and of each adjoining contributing character building. References of key elements from adjoining contributing character buildings (roof type/pitch, floor elevations, windows, building materials, building height, setbacks, scale and proportions) should be made in all new works.

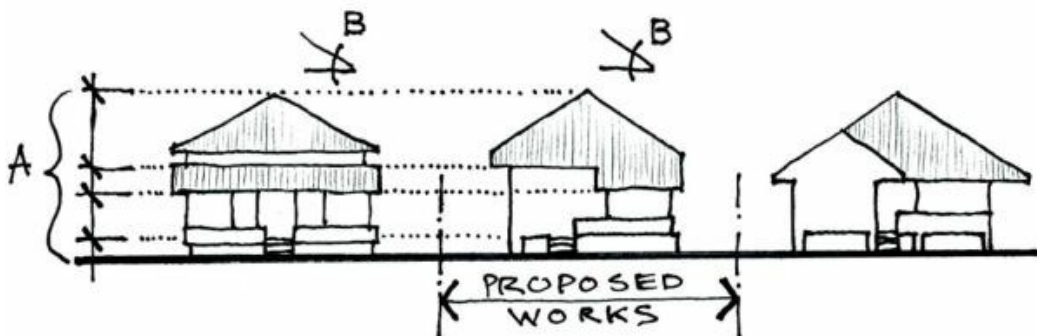

Figure SC6.2.6.1 Illustrates an example of clear elevations of the proposed works and adjoining contributing character buildings, with references made to key elements

SC6.2.6.2 Preparing an assessment report

The following is advice for preparing an assessment report for a property or building within the [Character residential zone code](#). This may be required to demonstrate achievement with the relevant performance outcomes in the Character residential zone code.

An assessment report may provide specific information about how a proposed development will affect the character residential precinct.

The report should include the following:

- (1) A brief description of the proposed development including:
 - (a) type of development;
 - (b) range and scope of work proposed;
 - (c) timeframe for carrying out work; and
 - (d) location of work in relation to the character residential precinct;

- (2) A description of the setting and context of the place, including photographs and maps showing significant features that will be affected. Provide an analysis of the affect the development will have on the streetscape;
- (3) A description of proposed changes to character including:
 - (a) what elements or aspects of streetscape are affected by the change;
 - (b) assessment of the proposal against the performance outcomes in the zone code;
 - (c) analysis of the impact of the change on the significance of the precinct;
 - (d) assessment of potential for detrimental impact on the significance of the precinct; and
 - (e) where the proposed change is assessed as having potential for detrimental impact, provide information about why the change is required, alternative solutions that were investigated, and what measures are included in the development to reduce detrimental impact that may result from the change; and
- (4) References list documents referred to in the assessment report such as conservation policies, conservation management plan, condition report (i.e. demolition report), and specialist consultants' reports. (Adapted from Guideline: *Preparing a Heritage Impact Statement* Department of Environment and Heritage Protection, 2011).

SC6.2.6.3 Preparing a condition report

If an application is proposing demolition of a contributing character building, the applicant may be requested to provide a condition report. The condition report should, at a minimum, include consideration of:

- (a) the structural stability of the building in the form of a structural engineer's report. The condition report must include a factual statement from an appropriately qualified structural engineer about the condition of the building; and
- (b) a pest inspection report and other supporting documentation may also be provided.

Appendix 1

SC6.2 APPENDIX 1: Non-contributing properties in the Character residential zone

Precinct A – 1950's Post War Expansion

Address	Comments
79 Lancaster Street	Original house that has been re-clad with face brick, including brickwork fence. Original roof form and windows have been retained, however brickwork is out of character
18 Lockheed Street	Contemporary rendered blockwork slab on ground house with double garage facing the street and rendered masonry front fence.
62 Perroux Street	High-set house
10 McHardie Street	Blockwork house
14 McHardie Street	Blockwork house
29 Downs Street	Blockwork house

Precinct B – 1960s Defence Housing and 1960s Housing Commission

Address	Comments
55 Clements Crescent	Substantial tornado damage
2 Lancaster Street	Low-set house
3 Lancaster Street	"Ranch Style" high set house – different style to predominant character
4 Lancaster Street	Low-set house
46 Douglas Street	Oriented to other street – does not relate to rest of precinct

Precinct C – Worker's Cottages

Address	Comments
4 Fifth Street	Vacant Lot
6 Fifth Street	Vacant Lot
3 Fifth Street	High-set horizontally massed house with shallow pitched roof
2 Flowers Street	High-set horizontally massed house
16 Flowers Street	Low-set Blockwork house
26 Flowers Street	Horizontally massed with prominent carport
77 Ninth Avenue	High-set horizontally massed house
1A Doorey Street	Low-set rendered house with prominent carport to front boundary
66 Tenth Avenue	Low-set blockwork duplex
60 Eleventh Avenue	High-set horizontally massed house
63 Eleventh Avenue	High-set horizontally massed house
73 Eleventh Avenue	High-set fibre cement clad house
75 Eleventh Avenue	High-set horizontally massed duplex
12 Fourteenth Avenue	Low-set blockwork house
14 Fourteenth Avenue	Low-set blockwork house
13 Fifteenth Avenue	High-set horizontally massed house
40 Seventh Street	Low-set fibre-cement house with skillion roof
7 Third Street	Low-set blockwork house
9 Third Street	High-set horizontally massed house with shallow pitched roof
14 Third Street	Low-set blockwork house (obscured by garden)
19 Third Street	High-set horizontally massed duplex
31 Flowers Street	Low-set blockwork house
258 Boundary Street	Blockwork Duplex
288 Boundary Street	Horizontally massed high-set house
1 Cape Street	Blockwork House
2 Cape Street	Horizontally massed high-set house
2 Comet Street	Low-set fibre cement house with shallow roof pitch
6 Fourth Avenue	Low-set house with shallow roof pitch
30A Sixth Avenue	Horizontally massed house with blockwork arches
37 Sixth Avenue	Vacant Lot
26 Sixth Street East	Horizontally massed high-set house
52A Sixth Street East	Vacant Lot
53 Sixth Street East	Vacant Lot
55 Sixth Street East	Water Police Office
57 Sixth Street East	Vacant Lot
56-58 Sixth Street East	Vacant Lot
19 Eighth Avenue	Horizontally massed two storey house
26 Perkins Street	Low-set blockwork house
37 Davidson Street	Low-set block house with large setback
40 Davidson Street	Low-set coloured blockwork house
42 Davidson Street	Rendered low-set house with tiled roof and garage door on street
15 Baxter Street	Original character house – raised to two storeys and poorly enclosed front verandah.
21 Baxter Street	Low-set brick block of units
22 Baxter Street	Rendered low-set house with visually prominent garage
7A Garrick Street	High-set fibre cement house with shallow pitched front gable
12 Garrick Street	Low-set brick house
16 Garrick Street	Low-set blockwork house
9-11 Castling Street	High-set "Ranch" style fibro house with shallow pitched roof
8 Castling Street	Blockwork lowest house
15 Estate Street	Modern, unsympathetic new dwelling, inconsistent setback, subdivision not consistent with other blocks

15A Estate Street	Modern, unsympathetic new dwelling, inconsistent setback, subdivision not consistent with other blocks
17 Estate Street	Low-set house with shallow front gable
18 Estate Street	Horizontally massed house
26 Estate Street	High-set 1950s era house
28 Estate Street	Low-set masonry – only visible expression is front double carport
3 Townsville Street	High-set fibre cement clad with shallow pitched front gable
4 Townsville Street	High-set horizontally massed house
5 Townsville Street	Unsympathetically raised house
7 Townsville Street	Character house with blank blockwork wall in front
15A Townsville Street	Rendered low-set house with prominent front carport
27 Townsville Street	Vacant lot
2 Edwards Street	Low-set rendered house with very shallow roof pitch
7 Edwards Street	Recent house with disproportionate front setback and prominent front carport
7A Edwards Street	Recent house with disproportionate front setback and prominent front carport
17 Edwards Street	Gable fronted two storey units
18 Edwards Street	Low-set house with brick walls and single front gable
6 Lamington Road	Brick “six pack” unit block
12-14 Lamington Road	Blockwork units, tiled roof
13 Lamington Road	Blockwork units
6 Humphrey Street	Two storey brickwork units
14 Humphrey Street	Low-set blockwork units
15 Humphrey Street	Low-set blockwork house
25 Humphrey Street	Unsympathetically raised and renovated character house
5 Plant Street	Two storey blockwork “six-pack” units
6 Shaw Street	Oversized modern highest house with gable – out of scale
22 Shaw Street	High-set “Ranch” style
25 Shaw Street	Low-set blockwork duplex
9 Shaw Street	Blockwork units

Precinct D – South Townsville (Residential)

Address	Comments
66 Allen Street	Rendered two storey house with prominent carparking
75 Allen Street	Low-set blockwork house
30 Allen Street	Low-set rendered house
10 Bell Street	Low-set fibre cement house
15 Bell Street	Horizontally massed high-set house
17 Bell Street	Brick and tile house
21 Bell Street	St Andrews Villas – Brick low-set
37A Bell Street	Rendered duplex
37B Bell Street	Rendered duplex
183 Boundary Street	Horizontally massed high-set house
283-285 Boundary Street	Low-set blockwork house
1 Cannan Street	Contemporary house under construction
17 Hubert Street	Character house raised on disproportionately high stumps
41 Macrossan Street	Horizontally massed high-set house
55 Macrossan Street	Two storey blockwork house
5 Martin Street	Low-set duplex with very prominent garages
10 Martin Street	Low-set rendered duplex
7 Nelson Street	Brick and tile house
13 Nelson Street	Wide low-set rendered house
18 Nelson Street	Brick duplex with blank gable end facade
21 Nelson Street	Vacant lot
22 Nelson Street	Low-set blockwork house

43-45 Nelson Street	Brickwork units
46 Nelson Street	Contemporary skillion roofed house – lacks front verandah
50 Nelson Street	Brick and tile house
52 Nelson Street	Brick and tile house
54 Nelson Street	Low-set blockwork house
71 Perkins Street	Low-set rendered house
85 Perkins Street	Vacant lot
115 Perkins Street	Unsympathetically converted commercial building
8 Tully Street	Blockwork duplex
42 Tully Street	Two storey brickwork house
44 Tully Street	Mock heritage low-set house
73 Tully Street	Rendered two storey house – lacks shade elements
81 Tully Street	Two storey blockwork house
91 Tully Street	Low-set blockwork house
97 Tully Street	Low-set rendered house
105 Tully Street	Multiple units

Precinct D – South Townsville (Non-Residential)

Address	Comments
50 Allen Street	Rendered recent commercial building – built to front boundary, however lacks street activation and awnings to footpath
12-20 Bell Street	Large contemporary warehouse building – Sigma Pharmaceuticals
20A Bell Street	Shades By Prior – rendered recent commercial building built to boundaries, however lacks substantial awnings to footpath
22 Bell Street	Map to Mine – commercial offices with large front setback
8 Cannan Street	Sabre Marine – large light industrial shed with large setback to the street and front hardstand area
10 Cannan Street	Basic commercial building with large front setback and extensive front carparking area
12 Cannan Street	Basic commercial building with large front setback and extensive front carparking area
6 Hubert Street	NSS (Northern Stevedoring Services) Shed with large hardstand area to street
3-7 Macrossan Street	South Townsville Self-Storage – secure self-storage complex
11 Macrossan Street	Portside Self-Storage – secure self-storage complex
13-17 Macrossan Street	U-Store – secure self-storage complex
36 Macrossan Street	Home-grown Hardwoods – large setback to the street and prominent front hardstand and storage area
38 Macrossan Street	SSAF Sheetmetal – Light industrial shed built to front and side boundaries however lacks street activation or awnings to footpath. May be suitable for retrofitting or refurbishment to improve character values.
45 Macrossan Street	Black River Cattle Equipment – light industrial use and rear shed destroys character values of retained house.
47 Macrossan Street	Abraham Steel Fabrications – large light industrial shed.
53 Macrossan Street	C&C Motors Shed – light industrial shed
46 Morey Street	Furniture warehouse with relatively blank blockwork façade to street and lack of shade to footpath. Appears suitable for retrofitting or refurbishment to improve character values.
19 Perkins Street	Light Industrial shed setback from street with hardstand area to front
41 Perkins Street	Murphy Steel Fabrications – Open light industrial shed with general storage in fenced yard.
75 Perkins Street	Dick Yuen Wholesale – Large front setback and extensive front hardstand area
99 Perkins Street	Kirk's Automotive Service – Shed to street frontage – interrupts an otherwise consistent row of character houses. Shed to rear of site may have some character value however is not readily visible from the street.

113 Perkins Street	Hood the Sailmakers Offices – blockwork commercial building. Built to front and side boundaries however lacks street activation and awnings to footpath. Appears suitable for retrofitting or refurbishment to improve character values.
3 Tully Street	U-store – secure self-storage complex
17 Tully Street	Shed with large front setback
50 Tully Street	Commercial complex with relatively blank blockwork façade to street and prominent driveway.
58 Tully Street	Warehouse complex. Built to front and side boundaries, however blank blockwork façade and lack of shade to footpath. Appears suitable for retrofitting/refurbishment.
80 Tully Street	Woodfield Engineering – basic light industrial shed
102 Tully Street	Fenced site – otherwise vacant

Precinct E – Queenslanders

Address	Comments
12 The Avenue	3 storey blockwork “Six-pack” units
16 The Avenue	2 storey brick units
7 Ackers Street	Three storey blockwork units
16 Ackers Street	Brickwork units
24 Ackers Street	Blockwork units
26 Ackers Street	Blockwork units
29-31 Ackers Street	Blockwork units
32 Ackers Street	Blockwork units
39 Ackers Street	Brick and tile house
42 Ackers Street	Low-set duplex
57 Ackers Street	Blockwork units
64 Ackers Street	Low-set blockwork duplex
66 Ackers Street	Horizontally massed high-set house
68 Ackers Street	Horizontally massed high-set house
69 Ackers Street	Low-set fibre cement units
2 Ahearne Street	Vacant lot
19 Ahearne Street	Brickwork base, horizontally massed highset house
25 Ahearne Street	Horizontally massed high-set house
27 Ahearne Street	Horizontally massed high-set house
35 Ahearne Street	Blockwork units
36 Ahearne Street	Horizontally massed high-set house
38 Ahearne Street	modern duplex
47 Ahearne Street	Blockwork units
51 Ahearne Street	Two storey contemporary units – some sympathetic elements however overall bulk and prominent garages are detrimental.
52 Ahearne Street	Vacant lot
54 Ahearne Street	Blockwork Units
70 Ahearne Street	Brickwork house
7 Armstrong Street	Blockwork low-set units
16 Armstrong Street	Horizontally massed high-set house
18 Armstrong Street	Three storey blockwork units
27 Armstrong Street	Low-set brick units
28 Armstrong Street	Horizontally massed high-set house
30 Armstrong Street	Low-set brick units
39 Armstrong Street	Two storey brick units
41 Armstrong Street	Fibre cement building with shallow roof pitch – used as offices
44 Armstrong Street	Two storey blockwork with arches
50 Armstrong Street	Blockwork low-set house
54 Armstrong Street	Brickwork units

56-58 Armstrong Street	Blockwork units
64 Armstrong Street	Vacant lot
78 Armstrong Street	Low-set rendered house
36-38 Ackers Street	Two storey brick units
4 Campbell Street	Blockwork units
6 Campbell Street	Blockwork units
2 Marks Street	Horizontally massed high-set house
16 Marks Street	Two storey blockwork units
18 Marks Street	Two storey rendered units
13 Philp Street	Rendered low-set units
16 Philp Street	Blockwork low-set units
19 Philp Street	Two storey brick house
21 Philp Street	Low-set rendered house
27 Philp street	Brick two storey units
37 Philp Street	Vacant Lot, not gazetted address, part of 35 Philip but fenced off
42 Philp Street	Rendered two storey units
9 Campbell Street	Masonry rendered 2 storey house (actually rear of lot at 42 Philip St, but driveway is to Campbell & post-box has number 9 on it.
14 Summerfield Street	Vacant lot
2A Ralston Street	Low-set blockwork units
2 Ralston Street	Low-set blockwork units
16 Ralston Street	Two storey blockwork units
18 Ralston Street	Vacant lot
45 Henry Street	Two storey blockwork units
125-127 Francis Street	Church, modern brickwork
129 Francis Street	Masonry units
146 Francis Street	Low-set blockwork house with very shallow roof pitch
154 Francis Street	Low-set house with stipple render finish
36 Leigh Street	Two storey units – face brickwork with fibre cement chamfer boards
56 Leigh Street	Light industrial building
25 Stagpole Street	Prominent three storey blockwork units
30 Stagpole Street	Horizontally massed high-set house
32 Stagpole Street	Blockwork low-set house with shallow roof pitch
33A Stagpole Street	Newly reconfigured house
40 Stagpole Street	Low-set rendered units (“6 pack”)
43A Stagpole Street	Newly reconfigured house
49 Stagpole Street	Open light industrial shed
52 Stagpole Street	Low-set shallow pitched hipped roof house with high fence and low floor height
82 Stagpole Street	Horizontally massed high-set house
83 Stagpole Street	Shallow pitched skillion roofed fibre cement clad house
86 Stagpole Street	Low-set blockwork units
93 Stagpole Street	Horizontally massed 1960’s era high-set house. Front setback blocks views to “Wolverton”.

Precinct F – Interwar Gables and Queensland Bungalows

Address	Comments
14 Chubb Street	Rendered front parapet (addition) and tall rendered fence
16 Chubb Street	Rendered
15 Taylor Street	Horizontally massed high-set house
16 Taylor Street	Vacant lot
20 Taylor Street	Horizontally massed high-set house
12 McKillop Street	Brick house with prominent front carport
3 Mawai Street	Low-set blockwork house with high fence
8 Mawai Street	Horizontally massed high-set house

4 Mears Street	Horizontally massed high-set house
6 Mears Street	Horizontally massed high-set house
11 Mears Street	Horizontally massed high-set house
22 Mears Street	Brick and tile units
24 Mears Street	Street frontage dominated by double carport with roller doors
34 Mears Street	Two storey block of units with shallow pitched roof
30 Hammond Street	Horizontally massed high-set duplex

Precinct G – Interwar to 1950s Asymmetrical Gable

Address	Comments
34 Hooper Street	Low-set blockwork duplex
35 Hooper Street	Low-set skillion roofed house with prominent front carport
26 Hooper Street	Vacant lot
53 Princes Road	Units
14 Princes Road	Two storey units
29 Princes Road	Units
30 Princes Road	Units
16 Sussex Street	Blockwork low-set house
3 Batt Street	Modern rendered with skillion roof
9 Batt Street	Slab on ground, flagstone veneer
3 Purves Street	Slab on ground, rendered modern
21 Kenilworth Street	Low pitch mono gable horizontally massed
22 Kenilworth Street	Low-set render low pitched roof
23 Kenilworth Street	Brick veneer, two storey
24 Kenilworth Street	Not representative of character, but good tropical house
12 Kenilworth Avenue	Two storey unit development
6 Surrey Street	High-set fibre cement clad house
14 Surrey Street	Brick low-set house
16 Surrey Street	Brick low-set house
20 Surrey Street	Brick House
19A Surrey Street	High-set fibre cement clad house
21A Surrey Street	“Six pack” unit block
31 Townsend Street	Rendered blockwork house with prominent front garage
5 Burton Street	Low-set blockwork duplex
34 Townsend Street	Skillion roofed low-set house with rendered walls. Possible 1950s era
7 Burton Street	Low-set brickwork duplex
12 Burton Street	Low-set blockwork house
25 Burton Street	Low-set blockwork duplex
26 Burton Street	Horizontally massed high-set house
5 Ballard Street	Horizontally massed high-set house
11 Ballard Street	Horizontally massed high-set house
13 Ballard Street	Horizontally massed low-set house
15 Ballard Street	Rendered low-set house with shallow front gable
16 Ballard Street	Two storey, two car garage to front
40 Purves Street	Horizontally massed high-set house
51 Purves Street	Two storey unit building
55 Purves Street	Low-set blockwork house
57 Purves Street	Vacant lot
25 Mindham Street	Low-set rendered duplex

Precinct H – Churchill Street

Address	Comments
9 Churchill Street	High-set house with shallow pitched gable roof
11 Churchill Street	Low-set blockwork house with shallow pitched roof and lack of windows oriented towards street

Precinct I – Park Street

Address	Comments
22 Gladstone Street	Terrace Style Unit development. Width of building facing Park Street far exceeds character houses.
24 Gladstone Street	Pre 1946 house, however house faces Gladstone Street and does not contribute to Park Street Precinct streetscape.
20 Park Street	Unit Development. Incorporates some sympathetic features such as front verandah and fence.
21 Park Street	60's era High-set house with fake brick cladding
23 Park Street	Blockwork unit development with blank street frontage and no fence.

Precinct J – Grand Queenslanders

Address	Comment
17 Alexandra Street	3 storey brickwork units
26 Alexandra Street	Rendered house with shallow roof pitch and no front verandah
32 Alexandra Street	Low-set brick and tiled roof house
40 Alexandra Street	Two storey blockwork house
43 Alexandra Street	Two storey 1950s house with flush lower level and dominant rendered front retaining wall.
44 Alexandra Street	4 storey blockwork units
46 Alexandra Street	Rendered two storey units with tiled roof
1 Burke Street	4 storey blockwork units
2 Burke Street	Low-set masonry units
32 Paxton Street	Two storey rendered units with blank façade and prominent parking
21 Cleveland Terrace	Rendered Units – wide form/bulk, Mediterranean style
19 Cleveland Terrace	Brick unit building. Wide, horizontal massing.
11 Cleveland Terrace	Brick unit building. Setback from street does not align with neighbours
27 Cleveland Terrace	Building site – design appears to be modern house with materials that are not related to surrounding context.
34 Cleveland Terrace	Shallow gabled low-set house. Overly large front setback. Fibre cement wall cladding.
7-11 Hamilton Street	Very large site – Vacant apart from small 70s/80s era fibre cement clad dwelling.
3-5 Hamilton Street	Vacant
25 Melton Terrace	70's era fibre cement clad units. Dilapidated.
7 Victoria Street	Two storey rendered house with shallow roof pitch and prominent double garage
18-20 Victoria Street	Blockwork and tile duplex
15-19 Victoria Street	Ridgemont Motel – Blockwork and tiled roof
26-28 Victoria Street	Skillion roofed house
273 Stanley Street	Skillion roofed cottage
277 Stanley Street	Derelict cottage
279 Stanley Street	Brick units
37 Hale Street	Two storey fibre cement clad unit building – lacks front verandah.
39 Hale Street	Modest low-set house with large street setback and no front verandah.

Precinct K – French Street

Address	Comments
18 French Street	Blockwork unit block with large setback
16 French Street	Blockwork House with tiled roof
20 French Street	Modern unsympathetic units
27 French Street	Enclosed block work on ground floor and the removal of external front staircase
13 French Street	Low-set rendered masonry units

Precinct L – Mixed 1950's

Address	Comments
2 Goodwin Street	Blockwork low-set house
28 Goodwin Street	1960's era high-set house
56 Goodwin Street	Rendered contemporary low-set house
66 Goodwin Street	Horizontally massed high-set duplex
69 Goodwin Street	Blockwork low-set house
101 Goodwin Street	Blockwork low-set with tiled roof
3 McDougall Street	Horizontally massed high-set duplex
4 McDougall Street	Horizontally massed high-set duplex
27 Haig Street	3 storey unit development
3-5 Haig Street	Unit Development
2B Haig Street	Unsympathetic modern dwelling
6 Haig Street	Low-set house with prominent flat roofed extension facing Haig Street
10 Isley Street	Brick veneer, timber floor low-set house
12 Isley Street	Brick veneer on slab
146 Howitt Street	Three storey apartment complex
146 Mitchell Street	Two storey units

SC6.2 APPENDIX 2: Contributing non-residential properties

Address	Comments
38-42 Allen Street	Former Petrol Station – currently Motolec Auto Electrical. Current use of forecourt for fenced general storage is detrimental to precinct character; however, site contains former petrol station buildings that are part of the mixed precinct character. Site would benefit from refurbishment and new use with greater street activation.
39 Allen Street	Pre1941 commercial building built to front boundary with 2 shopfronts and awning over footpath.
34 Archer Street	Former basic light industrial shed – patina of weathered corrugated iron and surrounding gardens contributory.
25 Bell Street	Character house converted into two storey commercial building. No setback to front boundary and includes awning to footpath.
33 Bell Street	Pre 1941 commercial building built to front boundary. Character value reduced by added blockwork façade and lack of awning to footpath.
173 Boundary Street	Pre 1941 small chamferboard shop to street with awning. High chainlink fence to property boundary is detrimental to the character.
265 Boundary Street	Small row of shopfronts with awning to footpath. Parts appear to be pre1941. Unusual 1960's era two storey units on the same parcel of land – units appear to have potential for retrofitting/refurbishment.
32 Hubert Street	St Patrick's Catholic Church and former school building.
20 Macrossan Street	Commonwealth Hotel. Two storey corner hotel with wraparound verandahs over footpath. Very important contributor to local character.
30 Macrossan Street	St Johns Anglican Church
65 Morey Street	Bahai Community Centre
25 Perkins Street	Building materials site with pre 1941 twin gabled sheds built to Perkins Street Boundary. Current use of site for open storage is detrimental to precinct character however sheds have character value and appear suitable for retrofitting or refurbishment.
45 Perkins Street	South Side Engineering – light industrial gabled shed with some character values and appears suitable for retrofitting or refurbishment.
89 Perkins Street	Former 1950s era Art Deco influenced brick and tile house. Features curved walls and unusual plan. Currently used as offices for Family Emergency Accommodation Townsville – generally retains residential appearance.
115-147 Perkins Street	Heritage listed Warehouse building with brick components dating from 1899. Property is in relatively poor condition. Site is very large and mainly open hardstand – the heritage building occupies the Cannan Street end only. Sympathetic retrofitting or refurbishment will be required to retain the character values of this property.

